



Table of Contents

1. Introduction	3
2. Regulatory and safety requirements.....	5
3. Installation.....	7
4. Troubleshooting	11
5. Maintenance	12
6. Warehousing and Dismantling.....	15
7. Technical specifications	16

1. Introduction



DANGER

It is necessary to read the whole manual carefully before doing any operation. Keor SPE must be used only in residential and commercial environments.

1.1 Purpose of the manual

The purpose of this manual is to provide the user with instructions for safely installing and using the Keor SPE battery cabinet, also called "equipment" in the rest of the manual. The battery cabinet is designed for a variety of UPS systems, and it provides extended runtime with a 36V_{DC}/72V_{DC} external connection. Additional parallel-connected battery cabinet provide the UPS with a longer extended runtime operation.

Only skilled technicians can carry out ordinary maintenance procedures.

Extraordinary maintenance operations are not dealt with because they are the sole preserve of the LEGRAND Technical Support Service.

The intended use and configurations envisaged for the equipment as shown in this manual are the only ones allowed by the Manufacturer.

Any other use or configuration must be previously agreed with the Manufacturer in writing and, in this case, the written agreement will be attached to the installation and user manuals.

The original text of this publication, drafted in English, is the only reference for the resolution of disputes of interpretation linked to translations into other languages.

1.2 Update of the manual

The manual reflects the state of the art when the equipment was put onto the market. The publication conforms to the directives current on that date. The manual cannot be considered inadequate when new standards come into force or modifications are made to the equipment.

Any addition to the manual the Manufacturer considers appropriate to send to the users, must be kept together with the manual of which they will become an integral part.

The version of the manual updated to its latest release is available on the Internet at <http://www.ups.legrand.com>

1.3 Guarantee terms

The guarantee terms may vary depending on the country where the equipment is sold. Check the validity and duration with LEGRAND's local sale representative.

If there should be a fault in the product, contact the LEGRAND Technical Support Service which will provide all the instructions on what to do.

Do not send anything back without LEGRAND's prior authorization.

LEGRAND is not responsible for costs such as:

- losses of profits or earnings;
- losses of equipment, data or software;
- claims by third parties;
- any damage to persons or things due to improper use, unauthorized technical alterations or modifications;

- any damage to persons or things due to installations where the full compliance with the standard regulating the specific usage applications have not been guaranteed.

The Manufacturer declines all indirect or direct responsibility arising from:

- assembly and cabling made by personnel not fully qualified according to national standards to work on equipment presenting electrical hazards;
- failure to observe the installation and maintenance instructions and use of the equipment which differs from the specifications in the manual;
- use by personnel who have not read and thoroughly understood the content of the user manual;
- use that does not comply with the specific standards used in the country where the equipment is installed;
- modifications made to the equipment, software, functioning logic unless they have been authorized by the Manufacturer in writing;
- repairs that have not been authorized by the LEGRAND Technical Support Service;
- damage caused intentionally, through negligence, by acts of God, natural phenomena, fire, or liquid infiltration.

1.4 Copyright

The information contained in this manual cannot be disclosed to any third party. Any partial or total duplication of the manual by photocopying or other systems, including electronic scanning, which is not authorized in writing by the Manufacturer, violates copyright conditions and may lead to prosecution. LEGRAND reserves the copyright of this publication and prohibits its reproduction wholly or in part without previous written authorization.

2. Regulatory and safety requirements

This section contains important safety and operating instructions that should always be followed during the installation, use and maintenance of the battery cabinet.

DANGER

The Keor SPE UPS and battery cabinet work with dangerous voltages. Only skilled technicians qualified and authorized by LEGRAND must perform ordinary maintenance operations. No part of the battery cabinet can be repaired by the user. Extraordinary maintenance operations must be carried out by LEGRAND Technical Support Service personnel.

- This product should be installed in compliance with installation rules, preferably by a qualified electrician. Incorrect installation and use can lead to risk of electric shock or fire. Before carrying out the installation, read the instructions and take account of the product's specific mounting location. Do not open, dismantle, alter or modify the device except where specifically required to do so by the instructions. All Legrand products must be opened and repaired exclusively by personnel trained and approved by Legrand. Any unauthorised opening or repair completely cancels all liabilities and the rights to replacement and guarantees. Use only Legrand brand accessories.
- Ensure that the mains supply voltage and frequency match those of the UPS (see the product label and the technical specifications).
- If any visible damage is found on the product during the unpacking operation, do not install the equipment but repack the unit and return it to your reseller or distributor.
- Before operating the UPS with its battery cabinet, ensure the UPS and the battery cabinet are connected to a properly grounded mains socket.
- Do not attempt to open or disassemble the battery cabinet; there are no user replaceable parts. Opening the case will void the warranty and introduces the risk of electric shock even when the mains plug is disconnected.
- The battery cabinet has dangerous voltages on its input and output connections. Contact with these voltages may be life threatening.
- In case of emergency, immediately turn off the equipment and disconnect the power cord from the AC power supply.
- Do not allow any liquid or any foreign object to enter the battery cabinet.
- The battery cabinet is intended for indoor installation in a ventilated, controlled indoor environment with a range of temperature between 0°C (+32°F) and +40°C (+104°F) and non-condensing humidity <95%.
- Do not install the equipment in locations with sparks, smoke, and hazardous gas or where there is water and excessive humidity. Dusty, corrosive, and salty environments can damage the equipment.
- Do not plug the battery cabinet input into its own output.
- Keep a clearance of 20 cm beyond the rear panel. Avoid exposing it to direct sunlight or installing it near heat emitting appliances.
- Unplug the battery cabinet prior to cleaning and do not use liquid or spray detergent.
- Do not place the equipment near equipment that generate strong electromagnetic fields and/or near equipment that are sensible to electromagnetic fields.
- The battery cabinet should be recharged every 2-3 months if unused. To do so, connect the power cable to a suitable grounded mains socket.
- To safeguard the batteries as well as possible it is necessary to bear in mind that their average lifetime is strongly influenced by the operating room temperature. Position the UPS in an environment with a temperature range between +20°C (+68°F) and +25°C (+77°F) to guarantee the optimum life of the batteries.

 **DANGER**

Make sure that the UPS is turned off and the both the UPS and the battery cabinet are completely disconnected from the AC power before carrying out and maintenance, battery replacement or repair.

 **CAUTION**

The batteries inside the battery cabinet are not user-replaceable. Servicing of batteries must be performed only by electrical hazard authorized personnel.

A battery can present a risk of electrical shock and burns by high short-circuit circuit current. Failed batteries can reach temperatures that exceed the burn thresholds for touchable surfaces. The following precautions should be observed when working on batteries:

- a) remove watches, rings, or other metal objects.
- b) use tools with insulated handles.
- c) wear rubber gloves and boots.
- d) do not lay tools or metal parts on top of batteries.
- e) disconnect the charging source prior to connecting or disconnecting battery terminals.
- f) determine if battery is inadvertently grounded. If inadvertently grounded, remove source from ground. Contact with any part of a grounded battery can result in electrical shock. The likelihood of such shock can be reduced if such grounds are removed during installation and maintenance (applicable to equipment and remote battery supplies not having a grounded supply circuit).
- g) never leave live cable terminals without an insulated protection.
- h) When replacing batteries, replace with the same type and number of batteries or battery packs. There is the risk of explosion if batteries are replaced by an incorrect type.

 **CAUTION**

Do not dispose of batteries in a fire. The batteries may explode.

Do not open or mutilate batteries. Released electrolyte is harmful to the skin and eyes. It may be toxic. The batteries installed inside the cabinet must be disposed of correctly. For the disposal requirements refer to local laws and relevant standards.







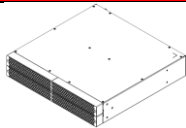

3. Installation

3.1 Package Inspection

During transportation, some unpredictable situations might occur. It is recommended that you inspect the UPS's exterior packaging. If you notice any damage, please immediately contact the dealer from whom you purchased the unit.

Also check the rating label on the UPS and make sure the device No. and capacity match what you ordered. Examine if any parts are loose or damaged.

The UPS package contains the following items. Please check if any items are missing.

No.	ITEM		QTY
1	Battery cabinet		1
2	Tower stands		2
3	Bracket ears		2
4	Quickstart		1
5	Handles		2
6	AC power cord		1
7	Power cord		1
8	Pan head screws M5		4
9	Pan head screws M4		12

3.2 Positioning constraints

The UPS can be installed vertically (tower-mounting) or horizontally (rack-mounting) according to the user's desired arrangement. Do not mount the UPS with its front or rear panel facing down at any angle.

Keep at least 100 mm of free space in front and at the rear of the UPS for proper ventilation.

Always keep the UPS upright and handle it with care.

Do not stack the units.

Do not place any objects on the UPS, the external battery pack (optional) or any other accessory associated with the UPS.

Install the UPS on a level and even surface.

For tower-mounting installation, ensure that your chosen location's floor can bear the weight of the UPS.

For rack-mounting installation, make sure your chosen cabinet can support the weight of the UPS and the rails that may be mounted in an associated rack. You also need to take your chosen location's floor weight loading into consideration.

For rack-mounting installation, do not let your rack become 'top heavy'. Install the heaviest equipment near the bottom of the rack.

3.3 Rear view

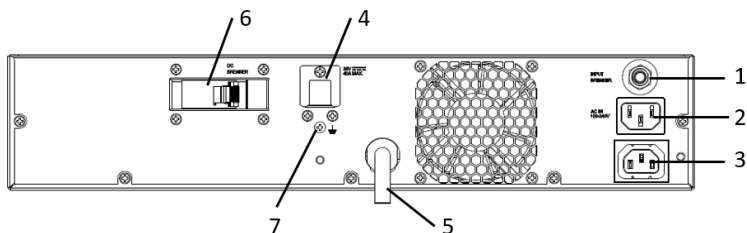

1. AC Circuit Breaker: Provides overload and fault protection.

2. AC Output Outlet: AC power connectivity to wall receptacle.

3. AC Input Inlet: Use this outlet to connect to the AC Input Inlet of a downstream battery cabinet.

4. Input Connector: Use this input connector to series connect another battery cabinet. Remove the connector cover for access.

5. Output Cable: Use this output cable to connect the battery cabinet to the UPS or another battery cabinet.

6. DC Breaker: Use the DC breaker to disconnect battery output.

7. External Ground Stud: The External Ground Stud is for connecting an external ground wire.

3.4 Rackmount installation

1. Attach the included bracket ears and handles to the lateral mounting holes of the UPS. The screws to be used are the M4 (12 pcs).

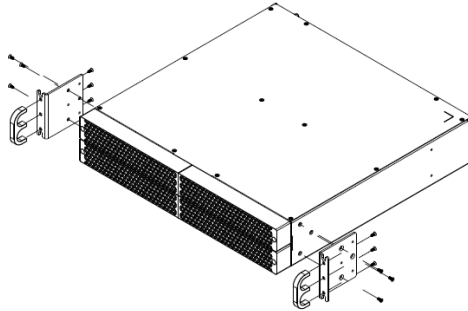

2. Insert the UPS into the rack and tighten the provided four screws. The screws to be used are the M5 screws.

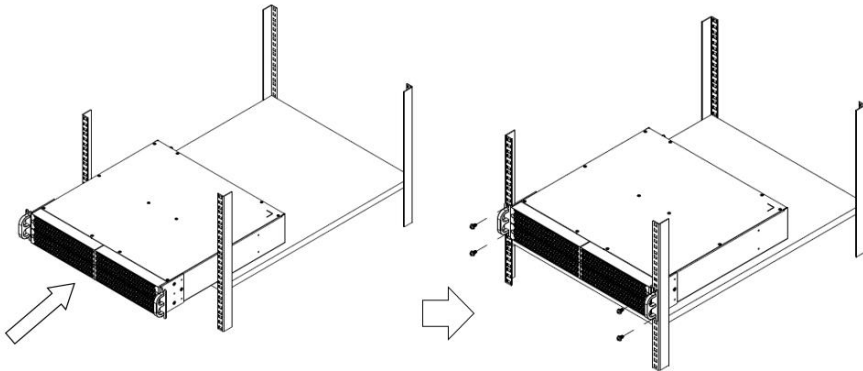

3.4 Installation procedure



WARNING

Read the safety instructions on chapter 2 before installing the battery cabinet.

1. Connect the 1st battery cabinet to the UPS using the previous instructions.
2. Turn off the DC breaker of the 2nd Battery module.
3. Loosen the two screws to remove the battery cable cover of the 1st battery cabinet.
4. Use the output cable of the 2nd battery cabinet to connect the 2nd battery cabinet to the 1st battery cabinet.
5. Use a power cord to plug AC input inlet of the 2nd battery cabinet into AC output outlet of the 1st battery cabinet.
6. Turn on the DC breaker of the 2nd Battery module.

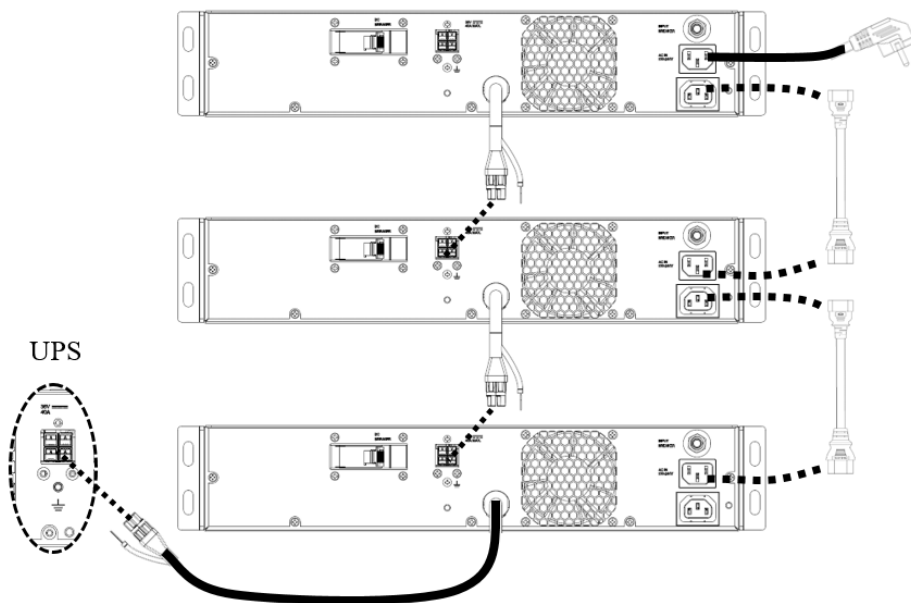

4. Troubleshooting

INDICATION	POSSIBLE CAUSE	SOLUTION
BAT Disconnected	Missing battery power	Check battery connector and battery breaker.
Battery Failure	The UPS has detected a bad battery	<ol style="list-style-type: none"> 1. Check battery connector and battery breaker. 2. Contact Legrand Technical Support for more information about Product's Battery Replacement Program.
Replace Battery	Battery will soon need to be replaced due to insufficient runtime	Contact Legrand Technical Support for more information about Product's Battery Replacement Program.
Overcharge	Battery is overcharged	<ol style="list-style-type: none"> 1. Remove battery connector and check charger voltage. 2. Contact Legrand Technical Support for repair information.
Charger Failure	Charger has failed	

5. Maintenance

5.1 Battery Replacement



CAUTION

All operations listed in this paragraph must be carried out only by a SKILLED TECHNICIAN.

This definition refers to people who have specific technical qualification and are aware of the methods of installing, assembling, repairing, and using the equipment safely.

The skilled technician is qualified according to national safety standards to work under dangerous electrical voltage and uses the personal protective equipment required by national safety standards.



DANGER

A battery can present a risk of electrical shock and high short circuit current.

Before the replacement, it is mandatory the reading of chapter 2 about safety requirements.

Batteries may only be replaced with the same number and type. Batteries must be brand new.

If the battery brand is different from the one originally installed by Legrand, the estimated battery autonomy indicated on the display of the UPS may not be reliable.

- 1) Remove the front plastic panel.

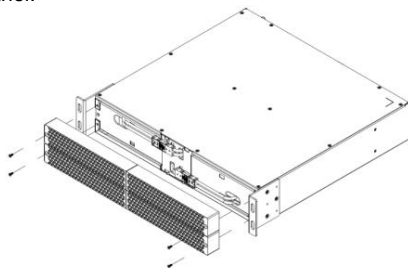

- 2) Disconnect the battery cables.

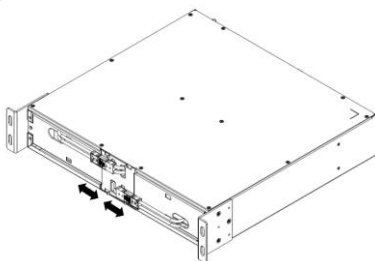

3) Pull out the battery cover by removing the one screw

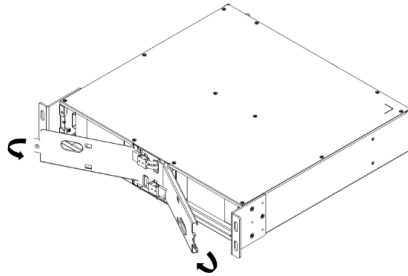

4) Remove the battery box.

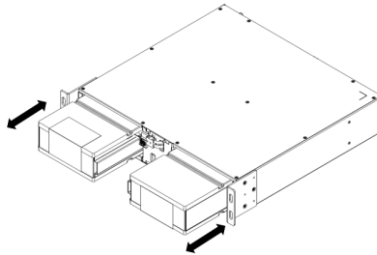

5) Put the battery box back in the original location and put back to its place the battery cover.

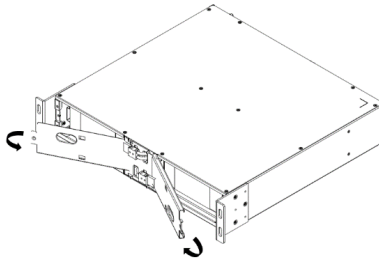

6) Reconnect the battery cables

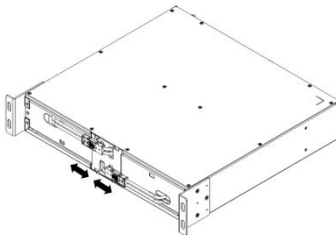

7) Put back the front panel of the cabinet.

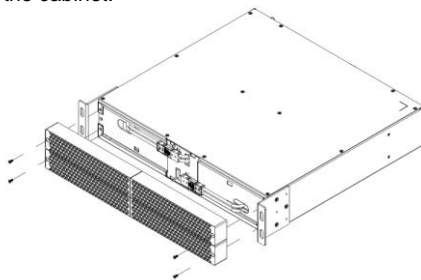

6. Warehousing and Dismantling

6.1 Warehousing

The battery cabinet can be stored in an environment with a room temperature between 0°C (+32°F) and +50°C (+122°F) and humidity less than 90% (not condensing).

However, it is recommended to store it in an environment with a room temperature between +20°C (+68°F) and +25°C (+77°F) to preserve the battery life.

The battery installed inside the cabinet is lead/acid sealed and does not require maintenance (VRLA). The battery should be charged for 8 hours every 3 months by connecting the UPS to the mains supply socket. Repeat this procedure every two months if the storage ambient temperature is above +25°C (+77°F).

INDICATION

Batteries must never be stored if partially or totally discharged.

LEGRAND is not liable for any damage or bad functioning caused to the UPS by wrong warehousing of the batteries.

6.2 Dismantling



Dismantling and disposal operations must be carried out only by a qualified electrician.

The instructions in this chapter are to be considered indicative: in every country there are different regulations regarding the disposal of electronic or hazardous waste such as batteries. It is necessary to strictly adhere to the standards in force in the country where the equipment is used.

Do not throw any component of the equipment in the ordinary rubbish.

6.2.1 Battery disposal



Batteries must be disposed of in a site intended for the recovery of toxic waste. Disposal in the traditional rubbish is not allowed.

Apply to the competent agencies in your countries for the proper procedure.



A battery may constitute a risk of electric shock and high short-circuit current.

When working on batteries, the prescriptions indicated in chapter 2 must be adhered to.

6.2.2 Electronic component dismantling

For the disposal of electronic waste, it is necessary to refer to the relevant standards.



This symbol indicates that in order to prevent any negative effects on the environment and on people, this product should be disposed of separately from other household waste, by taking it to authorised collection centres, in accordance with the EU countries local waste disposal legislations. Disposing of the product without following local regulations may be punished by law. It is recommended to check that this equipment subject to WEEE legislations in the country where it is used.

7. Technical specifications

INPUT/OUTPUT

	3 110 74	3 110 75	3 110 76	3 110 77
AC Input Voltage (V)	100 - 240			
DC Output Voltage (V)	36		72	
DC Output Current (A)	40			
Keor SPE UPS to be installed with	3 110 67	3 110 69	3 110 70	3 110 72

BATTERIES AND BATTERY CHARGER

	3 110 74	3 110 75	3 110 76	3 110 77
Number of batteries	6			
Number of Strings	2		1	
Battery Type	3 cells – 12 V Lead-acid sealed without maintenance (VRLA)			
Capacity (Ah)	7	9	7	9
Charge Current (A)	1.8 max		1.125 max	
Typical Recharge Time	6h for 0-90% capacity			
Interface	SA2-30			
Battery replacement	Hot-swappable			
Built-in Charger	Yes			

MECHANICAL CHARACTERISTICS

	3 110 74	3 110 75	3 110 76	3 110 77
Dimensions W x D x H (mm)	440 x 440 x 86.5			
Rack dimensions	2 U			
Net weight (kg)	18.1	22.2	18.1	22.2

ENVIRONMENTAL CONDITIONS

	3 110 74	3 110 75	3 110 76	3 110 77
Operating temperature (°C)	0 ÷ +40 (+20 ÷ +25 recommended for longer battery life)			
Relative humidity during operation	< 95% non-condensing			
Storage temperature (°C)	-0 ÷ +50 (+20 ÷ +25 recommended to preserve battery life)			
Protection Index (IEC 529)	IP 20			
Pollution degree	PD2			
Environmental category (IEC EN 60721-3-3)	3K2			
Mechanical category (IEC EN 60721-3-3)	3M1			

REFERENCE DIRECTIVES AND STANDARDS

Marks	CE, EAC, CMIM, UKCA
Safety	2014/35/EU Directive IEC/EN 62040-1
EMC	2014/30/EU Directive IEC/EN 62040-2

LEGRAND
Pro and Consumer Service
BP 30076 - 87002
LIMOGES CEDEX FRANCE
www.legrand.com

Installer stamp

Legrand reserves at any time the right to modify the contents of this booklet and to communicate, in any form and modality, the changes brought to the same.